

# FLOW RATE INDICATOR / TOTALIZER

WITH LINEARISATION AND ANALOG / PULSE  
SIGNAL OUTPUTS



## Features

- Displays instantaneous flow rate, total and accumulated total.
- 15 point linearisation of the flowcurve - with interpolation.
- Large 17mm (0.67") digit selection for flow rate or total.
- Selectable on-screen engineering units; volumetric or mass.
- Auto backup of settings and running totals.
- Operational temperature -30°C up to +80°C (-22°F up to 178°F).
- Very compact design for panel mount, wall mount or field mount applications.
- Rugged aluminum field mount enclosure IP67/NEMA4X.
- Intrinsically Safe  
⊕ II 1 GD EEx ia IIB/IIC T4 T100°C.
- Explosion/flame proof ⊕ II 2 GD EEx d IIB T5.
- Analog and pulse signal outputs.
- Full Modbus communication RS232/485/TTL.
- Loop or battery powered, 8 - 24V AC/DC or 115 - 230V AC power supply.
- Sensor supply 3.2 / 8.2 / 12 / 24V DC.

## Signal output

- (0)4 - 20mA / 0 - 10V DC according to linearised flow rate.
- Scaled pulse output according to linearised accumulated total.

## Signal input

### Flow

- Reed-switch.
- NAMUR.
- NPN/PNP pulse.
- Sine wave (coil).
- Active pulse signals.
- (0)4 - 20mA.
- 0 - 10V DC.

## Applications

- Liquid flow measurement with mechanical flowmeters where a precise calculation over the full measurement range is required. Also re-transmission of the flow rate and/or totalizer functions or serial communication is desired. Alternative basic model: F016 or more advanced F118.

## General information

### Introduction

The F112 provide very precise linearisation of the flowmeters signal. In addition to the average K-Factor or Span, fifteen linearisation points can be entered with there frequencies or values. The unit will interpolate between these points greatly enhancing accuracy in any flowrange. Even for very low frequency applications is catered for. This linearisation effects all displayed information as well as the signal outputs. A wide selection of options further enhance this models capabilities, including Intrinsic Safety and full Modbus communication.

### Display

The display has large 17mm (0.67") and 8mm (0.31") digits which can be set to show flow rate and totals. On-screen engineering units are easily configured from a comprehensive selection. The linearised accumulated total can register up to 11 digits and is backed-up in EEPROM memory every minute.

### Configuration

All configuration settings are accessed via a simple operator menu which can be pass-code protected. Each setting is clearly indicated with an alphanumerical description, therefore avoiding confusing abbreviations. Once familiar with one F-series product, you will be able to program all models in the series without a manual. All settings are safely stored in EEPROM memory in the event of sudden power failure.

### Analog output signal

The linearised flow rate is re-transmitted with the (0)4 - 20mA or 0 - 10V DC output signal. The output signal is updated ten times per second with a filter function being available to smoothen out the signal if desired.

The output value is user defined in relation to the flow rate, e.g. 4mA equals to 15L/Hr and 20mA equals to 2000L/Hr. The output signal can be passive, active or isolated where the passive output type will loop power the F112 as well.

### Pulse output

The scaleable pulse output, reflects the count on the accumulated display. The pulse length is user defined from 0.008 second up to 2 seconds.

The maximum output frequency is 64Hz.

The output signal can be a passive NPN, active PNP or an isolated electro-mechanical relay.

### Signal input

The F112 will accept most pulse and analog input signals for flow or mass flow measurement. The input signal type can be selected by the user in the configuration menu without having to adjust any sensitive mechanical dip-switches.

### Communication

All process data and settings can be read and modified manually or through the Modbus communication link (RS232 / RS485).

Full Modbus functionality remains available for the Intrinsically Safe version (TTL).

### Hazardous areas

For hazardous area applications, this model has been ATEX certified Intrinsically Safe  $\text{Ex II 1 GD EEx ia IIB / IIC T4 T100}^{\circ}\text{C}$  with an allowed operational temperature of  $-30^{\circ}\text{C}$  to  $+70^{\circ}\text{C}$  ( $-22^{\circ}\text{F}$  to  $+158^{\circ}\text{F}$ ). A flame proof enclosure is also available with the rating  $\text{Ex II 2 GD EEx d IIB T5}$ .

### Enclosures

Various types of enclosures can be selected, all ATEX approved. As standard the F112 is supplied in an GRP panel mount enclosure, which can be converted to an IP67 / NEMA 4X GRP field mount enclosure by the addition of a back case. Most popular is our rugged aluminum field mount enclosure with IP67 / NEMA 4X rating. Both European or U.S. cable gland entry threads are available.

## Overview application F112

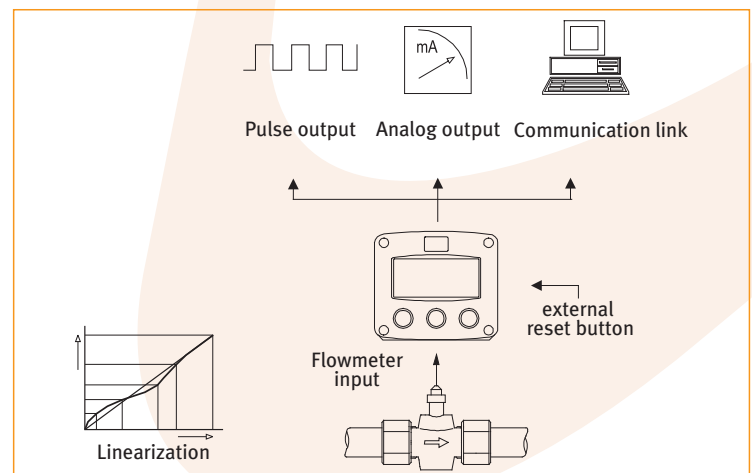

## Dimensions enclosures Aluminum & GRP panel mount enclosure

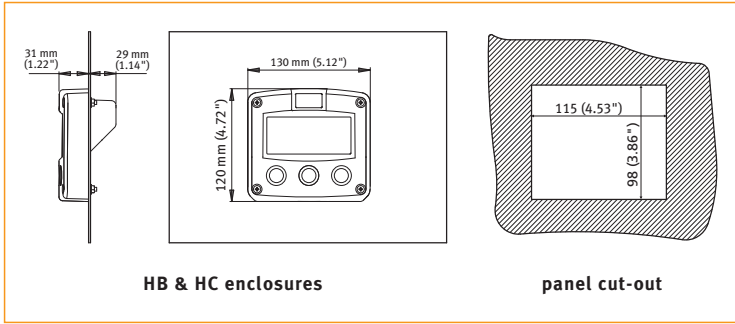

## Aluminum & GRP field / wall mount enclosures

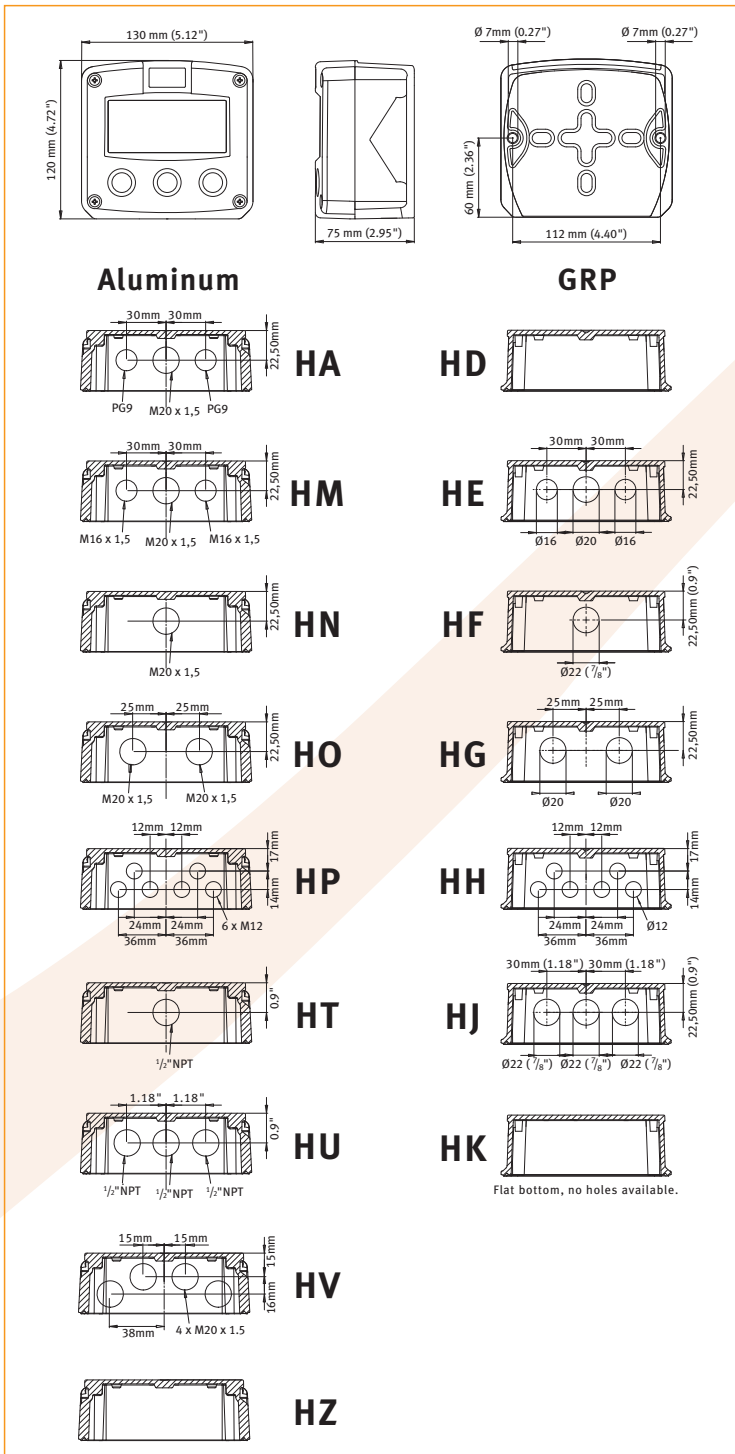

## Terminal connections

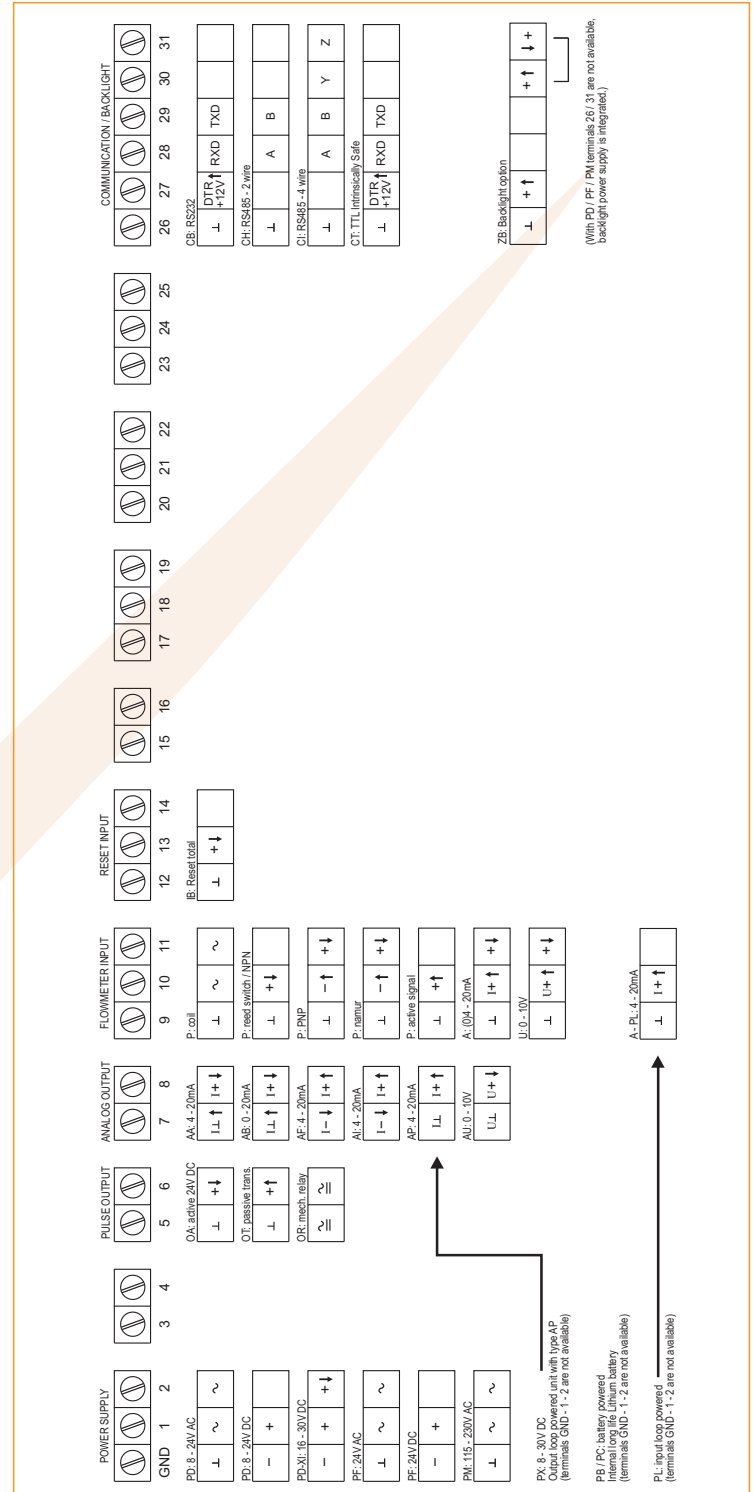

## Display example - 90 x 40mm (3.5" x 1.6")

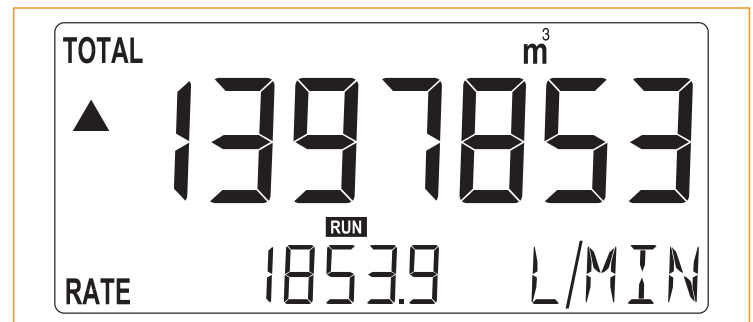

Typical wiring diagram F112-P-(AP)-CH-IB-(OT)-PB

Typical wiring diagram F112-P-AP-CH-IB-OT-PX

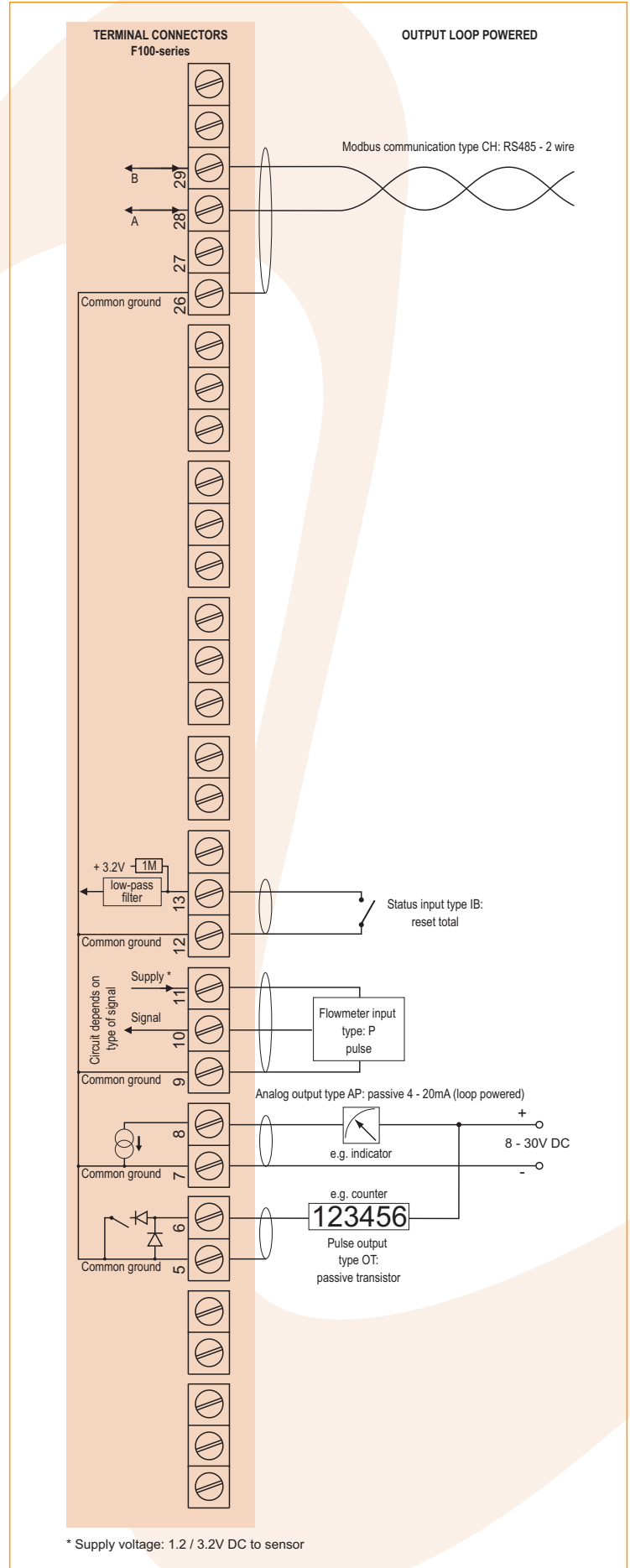
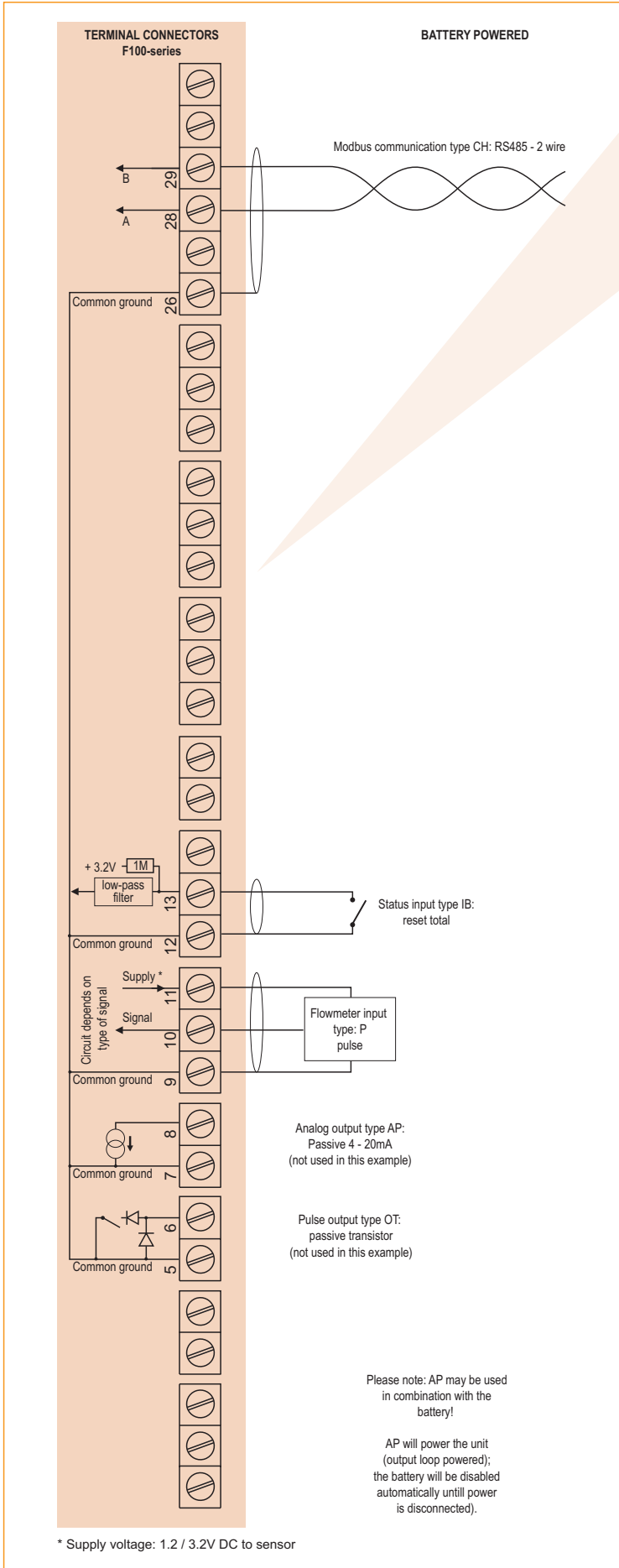

Typical wiring diagram F112-A-AA-CB-IB-OA-PD

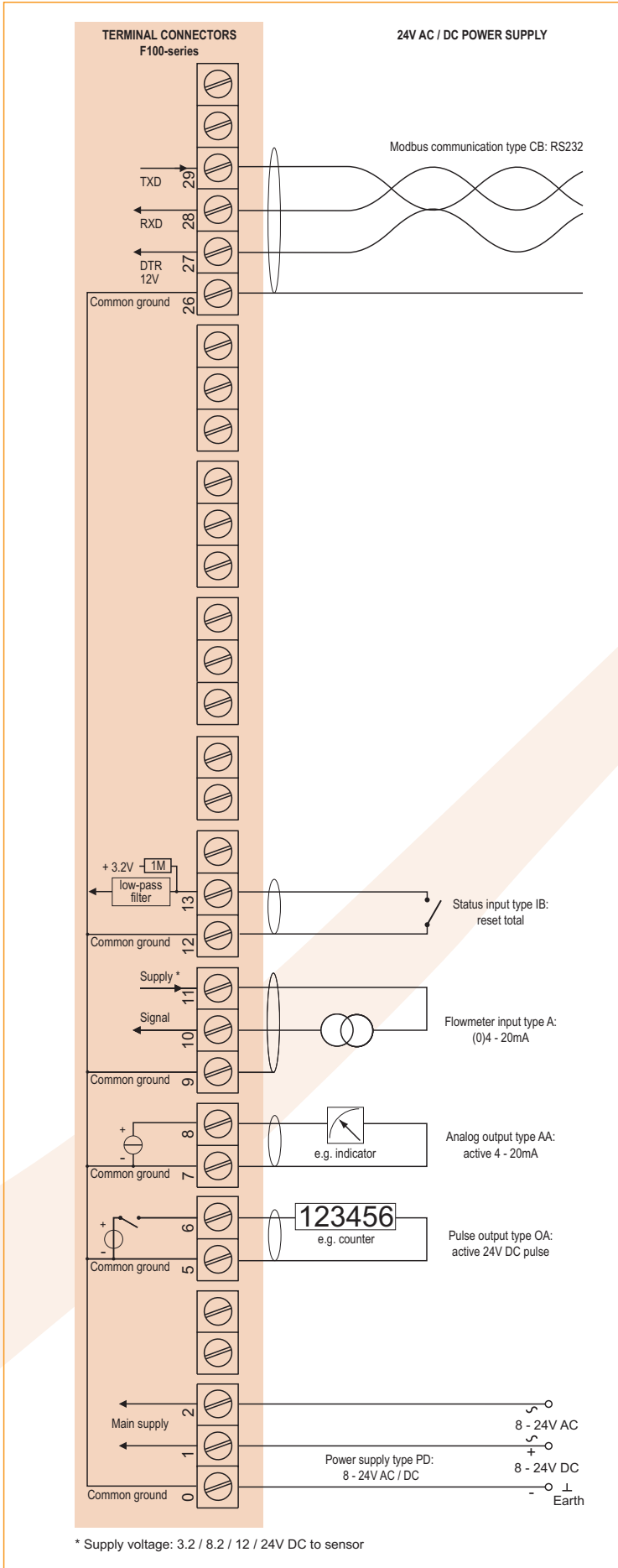

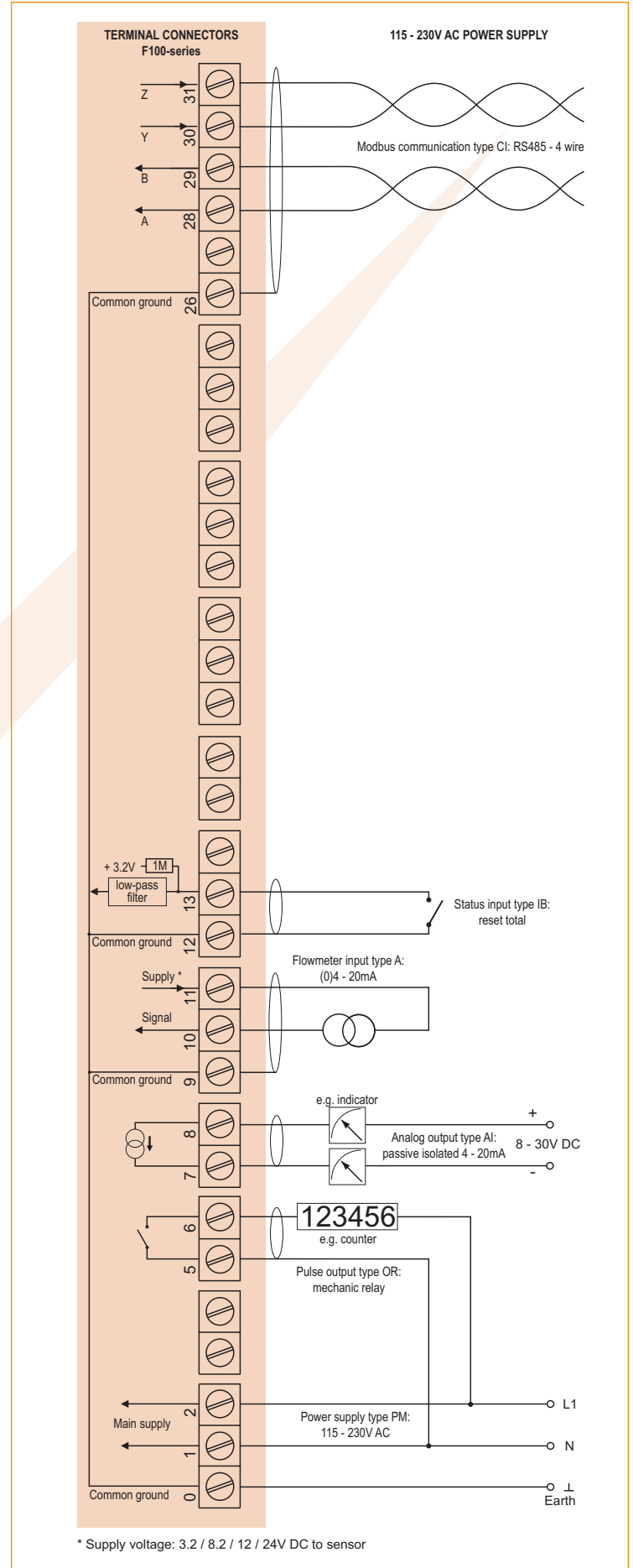

Typical wiring diagram F112-A-AI-CI-IB-OR-PM





## Hazardous area applications

The F112-XI has been ATEX approved by KEMA for use in Intrinsically Safe applications. It is approved according to  II 1 GD EEx ia IIB/IIC T4 T100°C for gas and dust applications with an operational temperature range of -30°C to +70°C (-22°F to +158°F). Besides the I.S. power supply for the pulse output, it is allowed to connect up to three I.S. power supplies in IIB applications or one in IIC applications. Full functionality of the F112 remains available, including 4 - 20mA output, pulse output and Modbus communication (type CT). Power supply type PD-XI offers a 8.2V sensor supply e.g. for one Namur sensor. A flame proof enclosure with rating ATEX  II 2 GD EEx d IIB T5 is available as well. Please contact your supplier for further details.

**Certificate of conformity KEMA 03ATEX1074 X**

## Configuration example IIB and IIC

### F112-P-(AP)-(CT)-IB-(OT)-PC-XI - Battery powered unit

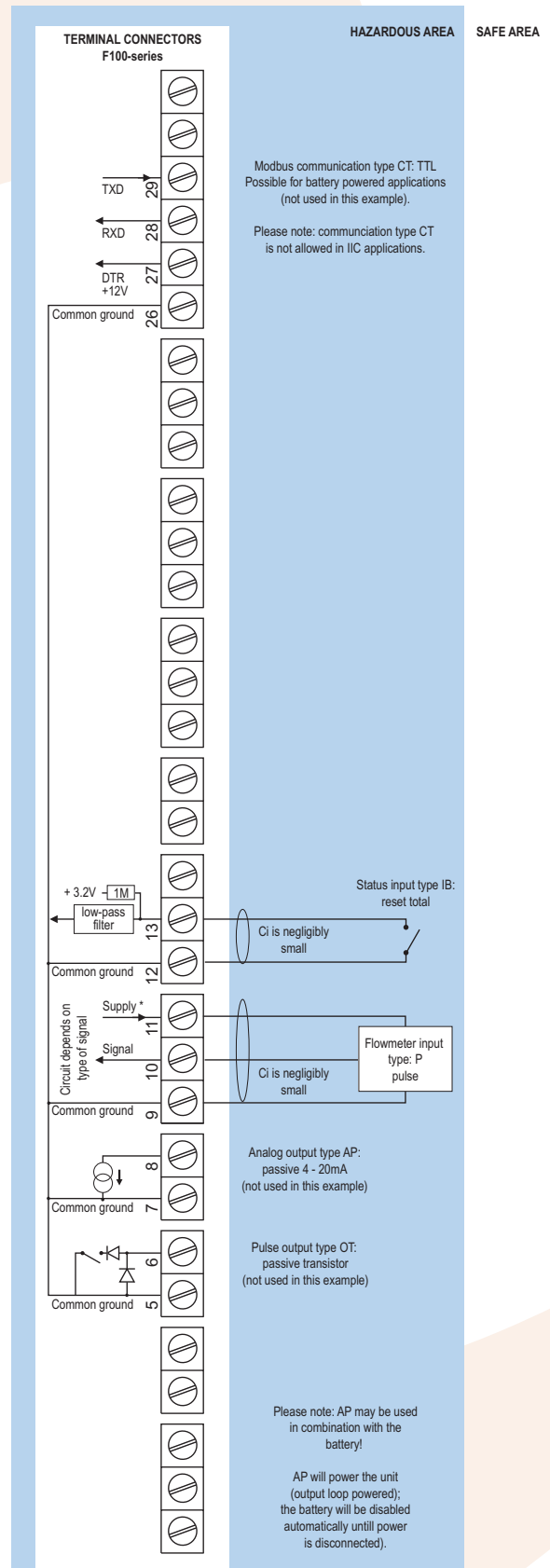

\* Note sensor supply voltage: 1.2V DC for coil sensors or 3.2V DC for other pulse sensors.



### (1) EC-TYPE EXAMINATION CERTIFICATE

(2) Equipment and protective systems intended for use in potentially explosive atmospheres - Directive 94/9/EC

- (3) EC-Type Examination Certificate Number: KEMA 03ATEX1074 X Issue Number: 2
- (4) Equipment: Indicator Model F1 Series
- (5) Manufacturer: Fluidwell B.V.
- (6) Address: Eisenhowerweg 1, 5466 AB Veghel, The Netherlands
- (7) This equipment and any acceptable variation thereto is specified in the schedule to this certificate and the documents therein referred to.
- (8) KEMA Quality B.V., notified body number 0344 in accordance with Article 9 of the Council Directive 94/9/EC of 23 March 1994, certifies that this equipment has been found to comply with the Essential Health and Safety Requirements relating to the design and construction of equipment and protective systems intended for use in potentially explosive atmospheres given in Annex II to the directive. The examination and test results are recorded in confidential test report number 2092823.
- (9) Compliance with the Essential Health and Safety Requirements has been assured by compliance with:
- |                          |                 |
|--------------------------|-----------------|
| EN 50014 : 1997 + A1, A2 | EN 50020 : 2002 |
| EN 50281-1-1 : 1998 + A1 | EN 50284 : 1999 |
- (10) If the sign "X" is placed after the certificate number, it indicates that the equipment is subject to special conditions for safe use specified in the schedule to this certificate.
- (11) This EC-Type Examination Certificate relates only to the design, examination and tests of the specified equipment according to the Directive 94/9/EC. Further requirements of the directive apply to the manufacturing process and supply of this equipment. These are not covered by this certificate.
- (12) The marking of the equipment shall include the following:



This certificate is issued on 11 September 2006 and, as far as applicable, shall be revised before the date of cessation of presumption of conformity of (one of) the standards mentioned above as communicated in the Official Journal of the European Union.

KEMA Quality B.V.

C.G. van Es  
Certification Manager

Page 1/6

\* Integral publication of this certificate and adjoining reports is allowed. This Certificate may only be reproduced in its entirety and without any change.

KEMA Quality B.V. Utrechtseweg 310, 6812 AR Arnhem P.O. Box 5185, 8802 ED Arnhem The Netherlands  
T +31 26 3 56 20 00 F +31 26 3 52 58 00 customer@kema.com www.kema.com Registered Arnhem 09085396

Experience you can trust.

## Configuration example IIB and IIC - F112-P-AP-(CT)-IB-OT-PX-XI - Output loop powered

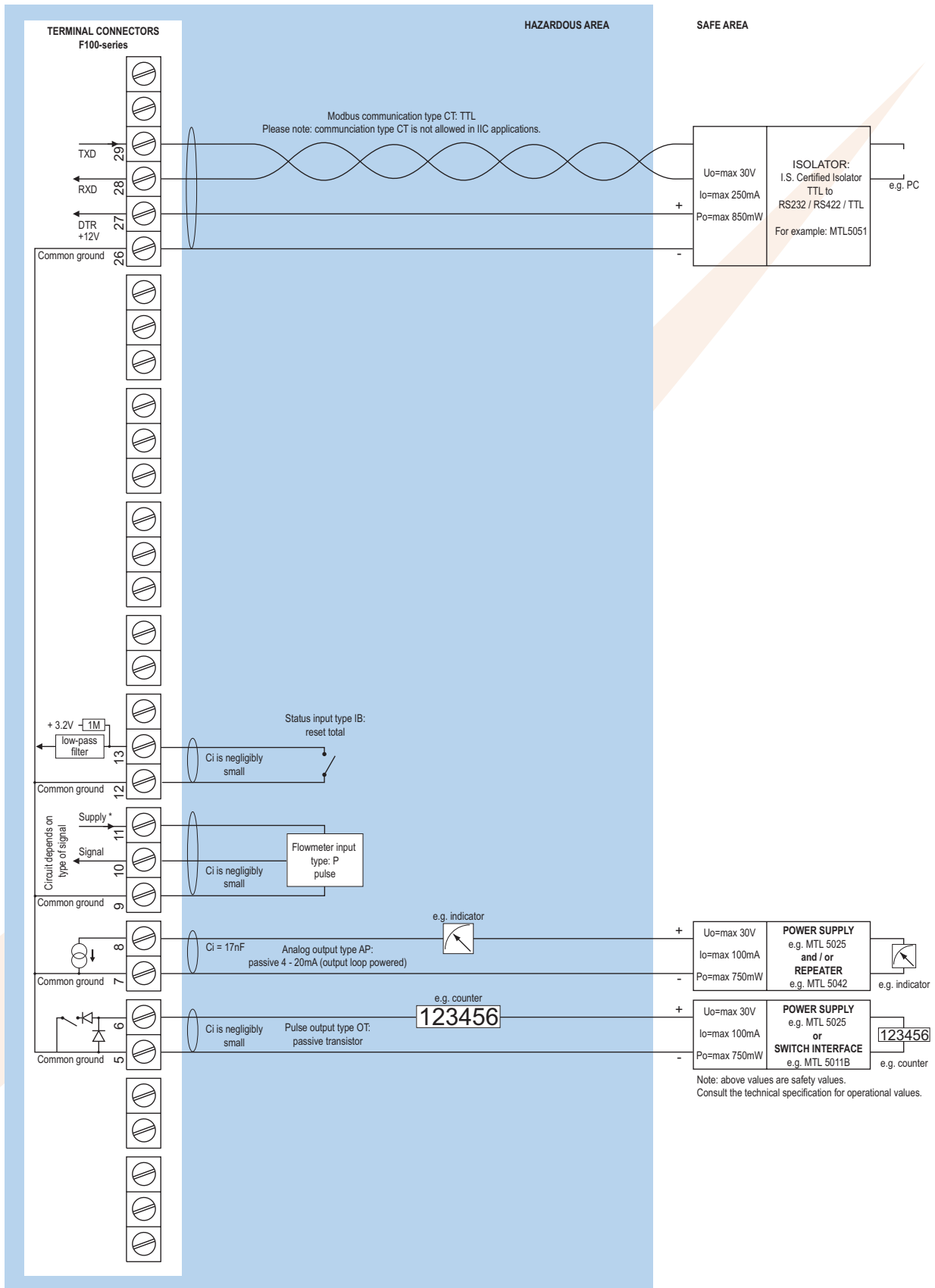

\* Note sensor supply voltage: 1.2V DC for coil sensors or 3.2V DC for other pulse sensors.

Configuration example IIB and IIC - F112-A-AF-(CT)-IB-OT-PD-XI - Power supply 16 - 30V DC

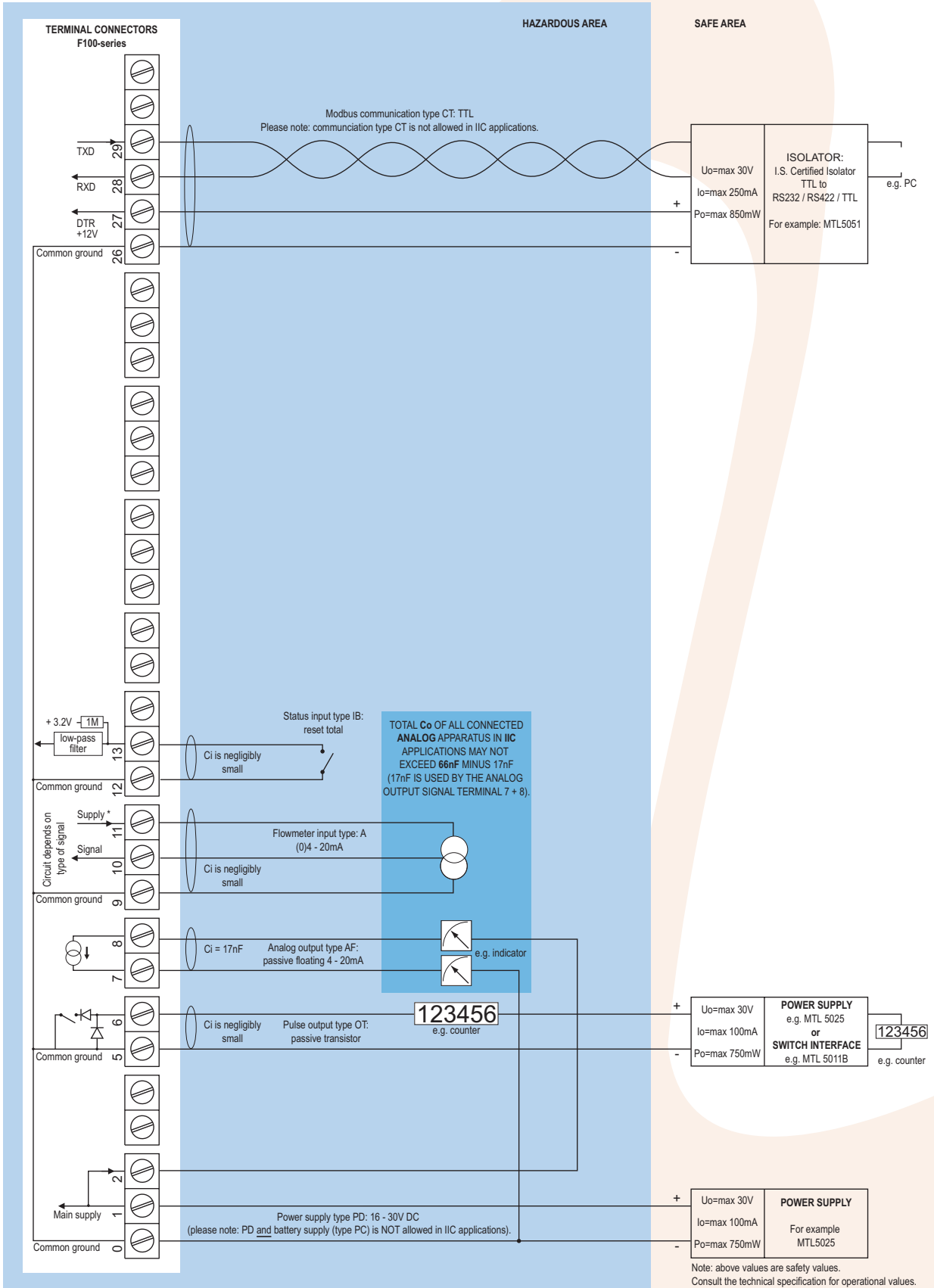

\* Note power supply type PD: the supply voltage to pulse sensors is maximum 8.7V (Uo=max 8.7V Io=max 25mA Po=max 150mW) and to analog sensors as connected to terminal 1 (internally linked).



**Configuration example IIB - F112-A-AF-CT-IB-OT-(PC)-(PD)-(PL)-XI - Power supply 16 - 30V DC, battery or loop powered**

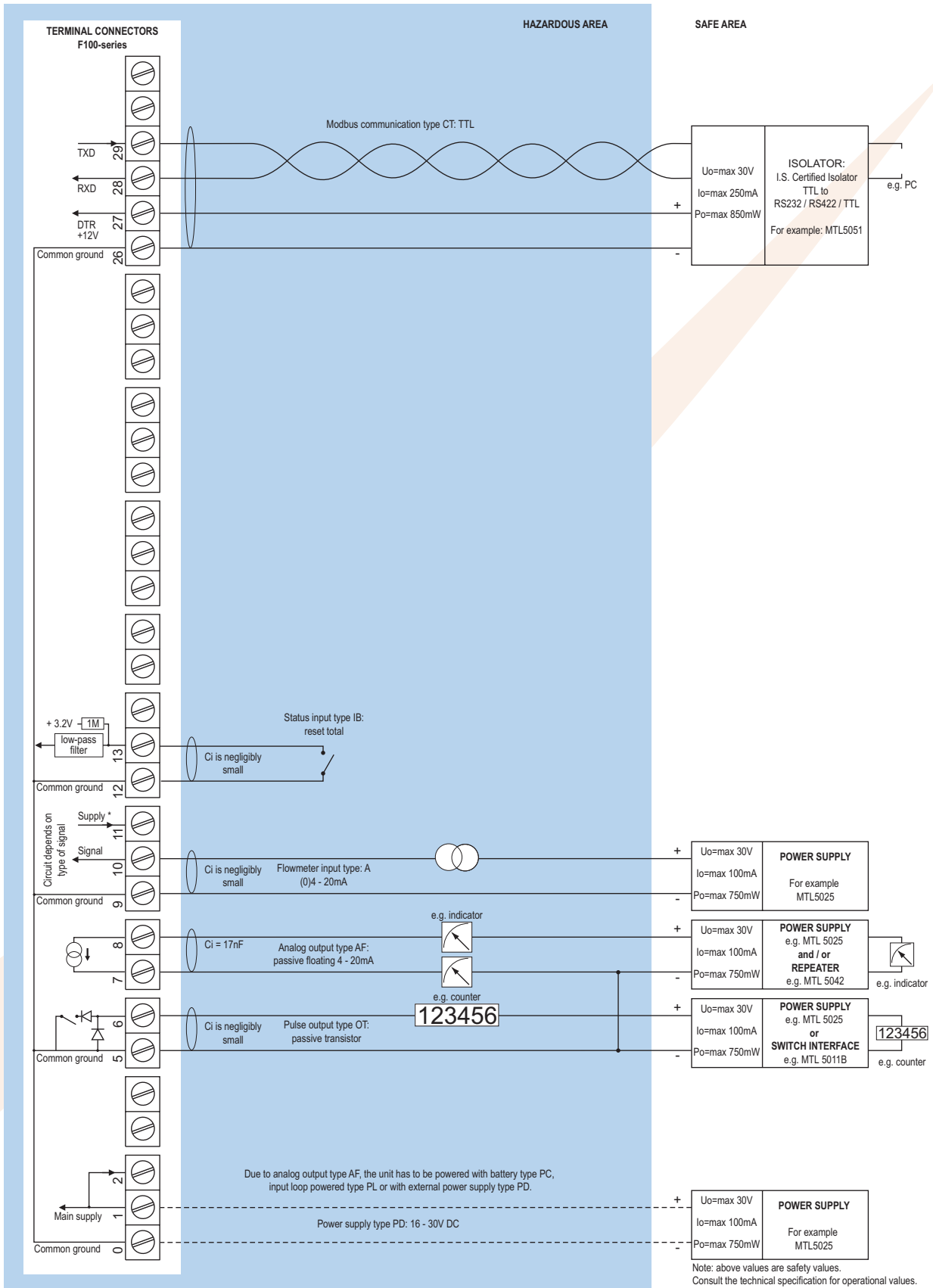

\* Note power supply type PD: the supply voltage to pulse sensors is maximum 8.7V (U<sub>o</sub>=max 8.7V I<sub>o</sub>=max 25mA P<sub>o</sub>=max 150mW) and to analog sensors as connected to terminal 1 (internally linked).

## Technical specification

### General

Display	
Type	High intensity reflective numeric and alphanumeric LCD, UV-resistant.
Dimensions	90 x 40mm (3.5" x 1.6").
Digits	Seven 17mm (0.67") and eleven 8mm (0.31") digits. Various symbols and measuring units.
Refresh rate	User definable: 8 times/sec. - 30 secs.
Option ZB	Transflective LCD with green LED backlight. Good readings in full sunlight and darkness.
Note ZB	Only available for safe area applications.

### Operating temperature

Operational	-30°C to +80°C (-22°F to +178°F).
Intrinsically Safe	-30°C to +70°C (-22°F to +158°F).

### Power requirements

Type PB	Long life Lithium battery - life-time depends upon settings and configuration - up to 5 years.
Type PC	Intrinsically Safe long life lithium battery - life-time depends upon settings and configuration - up to 5 years.
Type PD	8 - 24V AC / DC ± 10%. Power consumption max. 10 Watt. Intrinsically Safe: 16 - 30V DC; power consumption max. 0.75 Watt.
Type PF	24V AC / DC ± 10%. Power consumption max. 15 Watt.
Type PL	Input loop powered from sensor signal 4 - 20mA (type "A") - requires types AI or AF and OT.
Type PM	115 - 230V AC ± 10%. Power consumption max. 15 Watt.
Type PX	8 - 30V DC. Power consumption max. 0.5 Watt.
Type ZB	12 - 24V DC ± 10% or type PD / PF / PM. Power consumption max. 1 Watt.
Note PB/PF/PM	Not available Intrinsically Safe.
Note PF/PM	The total consumption of the sensors and outputs may not exceed 400mA @ 24V.
Note	For Intrinsically Safe applications, consult the safety values in the certificate.

### Sensor excitation

Type PB/PC/PX	3.2V DC for pulse signals and 1.2V DC for coil pick-up.
Note	This is not a real sensor supply. Only suitable for sensors with a very low power consumption like coils (sine wave) and reed-switches.
Type PD	1.2 / 3.2 / 8.2 / 12 / 24V DC - max. 50mA @ 24V DC.
Type PD-XI	1.2 / 3.2 / 8.2V DC - max. 7mA @ 8.2V DC and mains power supply voltage (as connected to terminal 1).
Note	In case PD-XI and signal A or U: the sensor supply voltage is according to the power supply voltage connected to terminal 1. Also terminal 2 offers the same voltage.
Type PF / PM	1.2 / 3.2 / 8.2 / 12 / 24V DC - max. 400mA @ 24V DC.

### Terminal connections

Type	Removable plug-in terminal strip. Wire max. 1.5mm <sup>2</sup> and 2.5mm <sup>2</sup> .
------	---

### Data protection

Type	EEPROM backup of all settings. Backup of running totals every minute. Data retention at least 10 years.
Pass-code	Configuration settings can be pass-code protected.

### Hazardous area

Intrinsically Safe	ATEX approval ref.:  II 1 GD EEx ia IIB/IIC T4 T100°C.
Type XI	Maximum ambient +70°C (158°F).
Explosion proof	ATEX approval ref.:  II 2 GD EEx d IIB T5.
Type XF	Dimensions of enclosure: 300 x 250 x 200mm (11.8" x 9.9" x 7.9") L x H x D.
Weight	appr. 15 Kg.

### Environment

Electromagnetic compatibility	Compliant ref: EN 61326 (1997), EN 61010-1 (1993).
-------------------------------	--

### Casing

#### General

Window	Polycarbonate window.
Sealing	Silicone.
Control keys	Three industrial micro-switch keys. UV-resistant silicone keypad.

### Aluminum wall / field mount enclosures

General	Die-cast aluminum wall/field mount enclosure IP67 / NEMA 4X with 2-component UV-resistant coating.
Dimensions	130 x 120 x 75mm (5.12" x 4.72" x 2.95") - W x H x D.
Weight	1100 gr.
Type HA	Cable entry: 2 x PG9 and 1 x M20.
Type HM	Cable entry: 2 x M16 and 1 x M20.
Type HN	Cable entry: 1 x M20.
Type HO	Cable entry: 2 x M20.
Type HP	Cable entry: 6 x M12.
Type HT	Cable entry: 1 x 1/2" NPT.
Type HU	Cable entry: 3 x 1/2" NPT.
Type HV	Cable entry: 4 x M20.
Type HZ	Cable entry: no holes.

### GRP wall / field mount enclosures

General	GRP wall/field mount enclosure IP67 / NEMA 4X, UV-resistant and flame retardant.
Dimensions	130 x 120 x 75mm (5.12" x 4.72" x 2.95") - W x H x D.
Weight	600 gr.
Type HD	Cable entry: no holes.
Type HE	Cable entry: 2 x Ø 16mm and 1 x Ø 20mm.
Type HF	Cable entry: 1 x Ø 22mm (7/8").
Type HG	Cable entry: 2 x Ø 20mm.
Type HH	Cable entry: 6 x Ø 12mm.
Type HJ	Cable entry: 3 x Ø 22mm (7/8").
Type HK	Flat bottom, cable entry: no holes.

### Panel mount enclosures

Dimensions	130 x 120 x 60mm (5.12" x 4.72" x 2.36") - W x H x D.
Panel cut-out	115 x 98mm (4.53" x 3.86") L x H.
Type HB	Die-cast aluminum panel mount enclosure IP65 / NEMA 4.
Weight	600 gr.
Type HC	GRP panel mount enclosure IP65 / NEMA 4, UV-resistant and flame retardant.
Weight	450 gr.

### ABS wall / field mount enclosures

General	Silicone free ABS wall/field mount enclosure IP65 with EPDM and PE sealings. UV-resistant polyester keypad (old HD enclosure).
Dimensions	130 x 114 x 71mm (5.1" x 4.5" x 2.8") - W x H x D.
Weight	450 gr.
Type HS	Cable entry: no holes.

## Signal inputs

Flowmeter	
Type P	Coil / sine wave (minimum 20mVpp or 80mVpp - sensitivity selectable), NPN/PNP, open collector, reed-switch, Namur, active pulse signals 8 - 12 and 24V DC.
Frequency	Minimum 0Hz - maximum 7kHz for total and flow rate. Maximum frequency depends on signal type and internal low-pass filter. E.g. reed switch with low-pass filter: max. frequency 120Hz.
K-Factor	0.000010 - 9,999,999 with variable decimal position.
Low-pass filter	Available for all pulse signals.
Option ZF	coil sensitivity 10mVpp.
Type A	(0)4 - 20mA. Analog input signal can be scaled to any desired range within 0 - 20mA.
Type U	0 - 10V DC. Analog input signal can be scaled to any desired range within 0 - 10V DC.
Accuracy	Resolution: 14 bit. Error < 0.025mA / $\pm$ 0.125% FS. Low level cut-off programmable.
Span	0.000010 - 9,999,999 with variable decimal position.
Update time	Four times per second.
Voltage drop	Type A: 2.5V @ 20mA.
Load impedance	Type U: 3k $\Omega$ .
Relationship	Linear and square root calculation.
Note	For signal type A and U: external power to sensor is required; e.g. type PD.

## Logic inputs

Function	L'entrée terminale à la remise se montent à distance.
Type IB	Contact intérieurement tiré-vers le haut de commutateur - NPN.
Durée	Durée minimum d'impulsion 100msec.

## Signal outputs

Analog output	
Function	Transmitting linearised flow rate.
Accuracy	10 bit. Error < 0.05%. Analog output signal can be scaled to any desired range.
Update time	Ten times per second.
Type AA	Active 4 - 20mA output (requires OA + PD, PF or PM).
Type AB	Active 0 - 20mA output (requires OA + PD, PF or PM).
Type AF	Passive floating 4 - 20mA output for Intrinsically Safe applications (requires XI + PC, PL or PD).
Type AI	Passive galvanically isolated 4 - 20mA output - also available for battery powered models (requires PB, PD, PF, PL or PM).
Type AP	Passive 4 - 20mA output - not isolated. Unit will be loop powered.
Type AU	Active 0 - 10V DC output (requires OA + PD, PF or PM).

## Pulse output

Function	Pulse output - transmitting accumulated total.
Frequency	Max. 64Hz. Pulse length user definable between 7.8 msec up to 2 seconds.
Type OA	One active 24V DC transistor output (PNP); max. 50mA per output (requires AA + PD, PF or PM).
Type OR	One electro-mechanical relay output - isolated; max. switch power 230V AC (N.O.) - 0.5A per relay (requires PF or PM).
Type OT	One passive transistor output (NPN) - not isolated. Max. 50V DC - 300mA per output.

## Communication option

Function	Reading display information, reading / writing all configuration settings.
Protocol	Modbus RTU.
Speed	1200 - 2400 - 4800 - 9600 baud.
Addressing	Maximum 255 addresses.
Type CB	RS232
Type CH	RS485 2-wire
Type CI	RS485 4-wire
Type CT	TTL Intrinsically Safe.

## Operational

### Operator functions

Displayed Functions	<ul style="list-style-type: none"> <li>Linearised flow rate and / or total.</li> <li>Linearised total and accumulated total.</li> <li>Total can be reset to zero by pressing the CLEAR-key twice.</li> </ul>
---------------------	--

### Total

Digits	7 digits.
Units	L, m <sup>3</sup> , GAL, USGAL, KG, lb, bbl, no unit.
Decimals	0 - 1 - 2 or 3.
Note	Total can be reset to zero.

### Accumulated total

Digits	11 digits.
Units / decimals	According to selection for total.
Note	Can not be reset to zero.

### Flow rate

Digits	7 digits.
Units	mL, L, m <sup>3</sup> , Gallons, KG, Ton, lb, bl, cf, RND, ft <sup>3</sup> , scf, Nm <sup>3</sup> , NI, iganal - no units.
Decimals	0 - 1 - 2 or 3.
Time units	/sec - /min - /hr - /day.

## Accessories

### Mounting accessories

ACFo2	Stainless steel wall mounting kit.
ACFo5	Stainless steel pipe mounting kit (worm gear clamps not included).
ACFo6	Two stainless steel worm gear clamps $\varnothing$ 44 - 56mm.
ACFo7	Two stainless steel worm gear clamps $\varnothing$ 58 - 75mm.
ACFo8	Two stainless steel worm gear clamps $\varnothing$ 77 - 95mm.
ACFo9	Two stainless steel worm gear clamps $\varnothing$ 106 - 138mm.
ACF10	Customized Grevopal tagplates for ACFo2 and ACFo5, including stainless steel screws. Dimension: 95mm x 12.5mm (3.75" x 0.50").

### Cable gland accessories

ACF20	For HA enclosure, includes O-rings.
ACF25	For HE enclosure, includes locknuts and O-rings.
ACF26	For HF enclosure, includes locknuts and O-rings.
ACF27	For HG enclosure, includes locknuts and O-rings.
ACF28	For HH enclosure, includes locknuts and O-rings.
ACF29	For HJ enclosure, includes locknuts and O-rings.
ACF32	For HM enclosure, includes O-rings.
ACF33	For HN enclosure, includes O-rings.
ACF34	For HO enclosure, includes O-rings.
ACF35	For HP enclosure, includes O-rings.
ACF39	For HT enclosure, includes O-rings.
ACF40	For HU enclosure, includes O-rings.

## Ordering information

Standard configuration: F112-P-AP-CX-EX-HC-IX-OT-PX-TX-XX-ZX.

Ordering information:	F112	-	A	-	C	-	EX	-	H	-	I	-	O	-	P	-	TX	-	X	-	Z
<b>Flowmeter input signal</b>																					
A	⊗	(0)4	-	20mA	input.																
P	⊗	<b>Pulse input: coil, npn, pnp, namur, reed-switch.</b>																			
U	⊗	0	-	10V	DC	input.															
<b>Analog output signal</b>																					
AA		Active	4	-	20mA	output	-	requires	OA	+	PD	,	PF	or	PM.						
AB		Active	0	-	20mA	output	-	requires	OA	+	PD	,	PF	or	PM.						
AF	⊗	I.S.	floating	4	-	20mA	output	-	requires	XI	+	PC	,	PL	or	PD.					
AI		Isolated	4	-	20mA	output	-	requires	PB	,	PD	,	PF	,	PL	or	PM.				
AP	⊗	<b>Passive 4 - 20mA output, loop powered unit.</b>																			
AU		Active	0	-	10V	DC	output	-	requires	OA	+	PD	,	PF	or	PM.					
<b>Communication</b>																					
CB		Communication	RS232	-	Modbus	RTU.															
CH		Communication	RS485	-	2-wire	-	Modbus	RTU.													
CI		Communication	RS485	-	4-wire	-	Modbus	RTU.													
CT	⊗	Intrinsically	Safe	TTL	-	Modbus	RTU.														
CX	⊗	<b>No communication.</b>																			
<b>Flow equations</b>																					
EX	⊗	<b>No flow equations.</b>																			
<b>Panel mount enclosures - IP65 / NEMA4</b>																					
HB	⊗	Aluminum enclosure.																			
HC	⊗	GRP enclosure.																			
<b>GRP field / wall mount enclosures - IP67 / NEMA4X</b>																					
HD	⊗	Cable entry: no holes.																			
HE	⊗	Cable entry: 2 x Ø 16mm & 1 x Ø 20mm.																			
HF	⊗	Cable entry: 1 x Ø 22mm (7/8").																			
HG	⊗	Cable entry: 2 x Ø 20mm.																			
HH	⊗	Cable entry: 6 x Ø 12mm.																			
HJ	⊗	Cable entry: 3 x Ø 22mm (7/8").																			
HK	⊗	Flat bottom, cable entry: no holes.																			
<b>Aluminum field / wall mount enclosures - IP67 / NEMA4X</b>																					
HA	⊗	Cable entry: 2 x PG9 + 1 x M20.																			
HM	⊗	Cable entry: 2 x M16 + 1 x M20.																			
HN	⊗	Cable entry: 1 x M20.																			
HO	⊗	Cable entry: 2 x M20.																			
HP	⊗	Cable entry: 6 x M12.																			
HT	⊗	Cable entry: 1 x 1/2" NPT.																			
HU	⊗	Cable entry: 3 x 1/2" NPT.																			
HV	⊗	Cable entry: 4 x M20.																			
HZ	⊗	Cable entry: no holes.																			
<b>ABS field / wall mount enclosures</b>																					
HS	⊗	Silicone free ABS field enclosure IP65 – Cable entry: no holes (old HD enclosure).																			
<b>Additional inputs</b>																					
IB	⊗	Terminal input to reset total.																			
IX	⊗	<b>No external input.</b>																			
<b>Outputs</b>																					
OA		One	active	transistor	output	-	requires	AA	,	AB	or	AU	and	PD	,	PF	or	PM.			
OR		One	mechanical	relay	output	-	requires	PF	or	PM.											
OT	⊗	<b>One passive transistor output - standard configuration.</b>																			
<b>Power supply</b>																					
PB		Lithium battery powered.																			
PC	⊗	Lithium battery powered - Intrinsically Safe.																			
PD	⊗	8 - 24V AC/DC + sensor supply - with XI: 16 - 30V DC.																			
PF		24V AC/DC + sensor supply.																			
PL	⊗	Input loop powered from sensor signal type "A" - requires AI or AF and OT.																			
PM		115 - 230V AC + sensor supply.																			
PX	⊗	<b>Basic power supply 8 - 30V DC (no real sensor supply). Unit requires external loop AP.</b>																			
<b>Temperature input signal</b>																					
TX	⊗	<b>No temperature input signal.</b>																			
<b>Hazardous area</b>																					
XI	⊗	Intrinsically Safe, according ATEX.																			
XF		EExd enclosure - 3 keys.																			
XX		<b>Safe area only.</b>																			
<b>Other options</b>																					
ZB		Backlight.																			
ZF	⊗	Coil input 10mVpp.																			
ZX	⊗	<b>No options.</b>																			

The bold marked text contains the standard configuration.

⊗ Available Intrinsically Safe.

Specifications are subject to change without notice.



Fluidwell bv  
P.O. Box 6  
5460 AA - Veghel - The Netherlands  
Tel.: +31 (0)413 343786  
Fax.: +31 (0)413 363443  
sales@fluidwell.com  
Internet: www.fluidwell.com



Vertrieb: Schwing Verfahrenstechnik GmbH  
Oderstraße 7  
47506 Neukirchen -Vluyn - Germany  
Tel.: +49 (0) 2845 930-0  
Fax: +49 (0) 2845 930-100  
E-mail: info@schwing-pmt.de  
http://www.schwing-pmt.de